



CORNWELL[®]
QUALITY TOOLS

MMW240TIG

OWNER'S MANUAL



WARNING:

Read carefully and understand all **ASSEMBLY AND OPERATION INSTRUCTIONS** before operating. Failure to follow the safety rules and other basic safety precautions may result in serious personal injury.

Effective December 22, 2015

LIMITED WARRANTY FOR MMW240TIG

This warranty applies to the original purchaser and is subject to the terms and conditions listed below. This Limited Warranty is for new equipment sold after the above date, providing coverage for defects in material and workmanship at the time it is shipped from the factory.

Limited to the warranty periods below, Cornwell Quality Tools will repair or replace the item under warranty that fails due to defects in material and workmanship. Cornwell Quality Tools must be notified within 30 days of the failure, so as to provide instructions on how to proceed with the repair of your welder and warranty claim processing. Warranty period begins at the time the welder is purchased from and Authorized Cornwell Distributor. **Keep your receipt as proof of purchase.**

Warranty Periods

Limited Warranty is divided into three categories. No Warranty, 1 year and 3 year.

No Warranty

Normal wear items such as TIG torch parts (tungsten, collet, collet body and nozzle), regulator and gas hose are considered consumable items and are not covered under warranty.

1 year

This warranty covers the existence of manufacturing defects in the TIG torch and foot pedal control, and the parts and labor associated with repairing those defects. This warranty does not cover damage, such as cuts in cabling, crushing, or any other damage that is a result of incorrect use of the torch or foot pedal. This warranty also does not cover the normal wear items as stated above in the No Warranty section. Any shipping related to warranty repair is the responsibility of the customer.

3 year

This warranty covers parts and labor on items such as: transformer, reactor, rectifier, solenoid valve, PC Board, switches, controls, gas valve, and any other component that requires the removal of the sheet metal to access; except for the TIG torch itself as outlined in the 1 year warranty above. Any shipping related to warranty repair is the responsibility of the customer.

Voiding Warranty

Warranty does not apply to: Shipping Damage, Misuse and abuse of the unit, alteration of the unit in any way.

Warranty Claim

This is a parts and labor warranty. **Contact your Cornwell distributor you purchased it from.** Retain your receipt in the case a warranty claim is needed. No warranty will be provided without the original receipt from an authorized Cornwell Distributor. To make a warranty claim, contact your Cornwell Distributor. That Cornwell Distributor will contact the customer service department for warranty instructions.

GENERAL SAFETY RULES



WARNING: Read and understand all instructions. Failure to follow all instructions listed below may result in serious injury.



CAUTION: Do not allow persons to operate or assemble this MMW240TIG until they have read this manual and have developed a thorough understanding of how the MMW240TIG works.



WARNING: The warnings, cautions, and instructions discussed in this instruction manual cannot cover all possible conditions or situations that could occur. It must be understood by the operator that common sense and caution are factors which cannot be built into this product, but must be supplied by the operator.

SAVE THESE INSTRUCTIONS

IMPORTANT SAFETY CONSIDERATIONS

1.1 Your Welding Environment

- Keep the environment you will be welding in free from flammable materials.
- Always keep a fire extinguisher accessible to your welding environment.
- Always have a qualified person install and operate this equipment.
- Make sure the area is clean, dry and ventilated. Do not operate the welder in humid, wet or poorly ventilated areas.
- Always have your welder maintained by a qualified technician in accordance with local, state and national codes.
- Always be aware of your work environment. Be sure to keep other people, especially children, away from you while welding.
- Keep harmful arc rays shielded from the view of others.
- Mount the welder on a secure bench or cart that will keep the welder secure and prevent it from tipping over or falling.

1.2 Your Welder's Condition

- Check ground cable, power cord and welding cable to be sure the insulation is not damaged. Always replace or repair damaged components before using the welder.
- Check all components to ensure they are clean and in good operating condition before use.

1.3 Use of Your Welder

▲ CAUTION

Do not operate the welder if the output cable, electrode, torch, wire or wire feed system is wet. Do not immerse them in water. These components and the welder must be completely dry before attempting to use them.

- Follow the instructions in this manual.
- Keep welder in the off position when not in use.

- Connect ground lead as close to the area being welded as possible to ensure a good ground.
- Do not allow any body part to come in contact with the torch if you are in contact with the material being welded, ground or electrode from another welder.
- Do not weld if you are in an awkward position. Always have a secure stance while welding to prevent accidents. Wear a safety harness if working above ground.
- Do not drape cables over or around your body.
- Wear a full coverage helmet with appropriate shade (see ANSI Z87.1 safety standard) and safety glasses while welding.
- Wear proper gloves and protective clothing to prevent your skin from being exposed to hot metals, UV and IR rays.
- Do not overuse or overheat your welder. Allow proper cooling time between duty cycles.
- Keep hands and fingers away from moving parts and stay away from the drive rolls.
- Do not point torch at any body part of yourself or anyone else.
- Always use this welder in the rated duty cycle to prevent excessive heat and failure.

1.4 Specific Areas of Danger, Caution or Warning



Electrical Shock

▲ WARNING

Electric arc welders can produce a shock that can cause injury or death. Touching electrically live parts can cause fatal shocks and severe burns. While welding, all metal components connected to the wire are electrically hot. Poor ground connections are a hazard, so secure the ground lead before welding.

- Wear dry protective apparel: coat, shirt, gloves and insulated footwear.
- Insulate yourself from the work piece. Avoid contacting the work piece or ground.
- Do not attempt to repair or maintain the welder while the power is on.
- Inspect all cables and cords for any exposed wire and replace immediately if found.
- Use only recommended replacement cables and cords.
- Always attach ground clamp to the work piece or work table as close to the weld area as possible.
- Do not touch the TIG torch tungsten and the ground or grounded work piece at the same time.
- Do not use a welder to thaw frozen pipes.



Fumes and Gases

▲ WARNING

- Fumes emitted from the welding process displace clean air and can result in injury or death.
- Do not breathe in fumes emitted by the welding process. Make sure your breathing air is clean and safe.
- Work only in a well-ventilated area or use a ventilation device to remove welding fumes from the environment where you will be working.
- Do not weld on coated materials (galvanized, cadmium plated or containing zinc, mercury or barium). They will emit harmful fumes that are dangerous to breathe. If necessary use a ventilator, respirator with air supply or remove the coating from the material in the weld area.
- The fumes emitted from some metals when heated are extremely toxic. Refer to the material safety data sheet for the manufacturer's instructions.
- Do not weld near materials that will emit toxic fumes when heated. Vapors from cleaners, sprays and degreasers can be highly toxic when heated.



UV and IR Arc Rays

▲ DANGER

The welding arc produces ultraviolet (UV) and infrared (IR) rays that can cause injury to your eyes and skin. Do not look at the welding arc without proper eye protection.

- Always use a helmet that covers your full face from the neck to top of head and to the back of each ear.
- Use a lens that meets ANSI standards and safety glasses. For welders under 160 Amps output, use a shade 10 lens; for above 160 Amps, use a shade 12. Refer to the ANSI standard Z87.1 for more information.
- Cover all bare skin areas exposed to the arc with protective clothing and shoes. Flame-retardant cloth or leather shirts, coats, pants or coveralls are available for protection.
- Use screens or other barriers to protect other people from the arc rays emitted from your welding.
- Warn people in your welding area when you are going to strike an arc so they can protect themselves.



Fire Hazards

▲ WARNING

Do not weld on containers or pipes that contain or have had flammable, gaseous or liquid combustibles in them. Welding creates sparks and heat that can ignite flammable and explosive materials.

- Do not operate any electric arc welder in areas where flammable or explosive materials are present.
- Remove all flammable materials within 35 feet of the welding arc. If removal is not possible, tightly cover them with fireproof covers.
- Take precautions to ensure that flying sparks do not cause fires or explosions in hidden areas, cracks or areas you cannot see.
- Keep a fire extinguisher close in the case of fire.
- Wear garments that are oil-free with no pockets or cuffs that will collect sparks.
- Do not have on your person any items that are combustible, such as lighters or matches.
- Keep work lead connected as close to the weld area as possible to prevent any unknown, unintended paths of electrical current from causing electrical shock and fire hazards.



Hot Materials

▲ CAUTION

Welded materials are hot and can cause severe burns if handled improperly.

- Do not touch welded materials with bare hands.
- Do not touch torch nozzle after welding until it has had time to cool down.

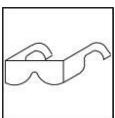

Sparks/Flying Debris

▲ CAUTION

Welding creates hot sparks that can cause injury. Chipping slag off welds creates flying debris.

- Wear protective apparel at all times: ANSI-approved safety glasses or shield, welder's hat and ear plugs to keep sparks out of ears and hair.



Electromagnetic Field

⚠ CAUTION

-Electromagnetic fields can interfere with various electrical and electronic devices such as pacemakers.

- Consult your doctor before using any electric arc welder or cutting device
- Keep people with pacemakers away from your welding area when welding.
- Do not wrap cable around your body while welding.
- Wrap torch and ground cable together whenever possible.
- Keep torch and ground cables on the same side of your body.



Shielding Gas Cylinders Can Explode

⚠ WARNING

High pressure cylinders can explode if damaged, so treat them carefully.

- Never expose cylinders to high heat, sparks, open flames, mechanical shocks or arcs.
- Do not touch cylinder with torch.
- Do not weld on the cylinder.
- Always secure cylinder upright to a cart or stationary object.
- Keep cylinders away from welding or electrical circuits.
- Use the proper regulators, gas hose and fittings for the specific application.
- Do not look into the valve when opening it.
- Use protective cylinder cap whenever possible

1.5 Proper Care, Maintenance and Repair

⚠ DANGER

- Always have power disconnected when working on internal components.
- Do not touch or handle PC board without being properly grounded with a wrist strap. Put PC board in static proof bag to move or ship.
- Do not put hands or fingers near moving parts such as drive rolls or fan.



H.F. RADIATION can cause interference.

- High-frequency (H.F.) can interfere with radio navigation, safety services, computers, and communications equipment.
- Have only qualified persons familiar with electronic equipment perform this installation.
- The user is responsible for having a qualified electrician promptly correct any interference problem resulting from the installation.
- If notified by the FCC about interference, stop using the equipment at once.
- Have the installation regularly checked and maintained.
- Keep high-frequency source doors and panels tightly shut, keep spark gaps at correct setting, and use grounding and shielding to minimize the possibility of interference.



ARC WELDING can cause interference.

- Electromagnetic energy can interfere with sensitive electronic equipment such as computers and computer-driven equipment such as robots.
- Be sure all equipment in the welding area is electromagnetically compatible.
- To reduce possible interference, keep weld cables as short as possible, close together, and down low, such as on the floor.
- Locate welding operation 100 meters from any sensitive electronic equipment.
- Be sure this welding machine is grounded.
- If interference still occurs, the user must take extra measures such as moving the welding machine, using shielded cables, using line filters, or shielding the work area.

MMW240TIG USE AND CARE

- **Do not modify this unit in any way.** Unauthorized modification may impair the function and/or safety and could affect the life of the equipment. There are specific applications for which this unit was designed.
- **Always check of damaged or worn out parts before using this unit.** Broken parts will affect the operation. Replace or repair damaged or worn parts immediately.
- **Store idle.** When this unit is not in use, store it in a secure place out of the reach of children. Inspect it for good working condition prior to storage and before re-use.

TECHNICAL SPECIFICATIONS

Item	Description
Power Supply	230V, 35A, 50/60 Hz, Single Phase
Output No Load Voltage	68V
Rated Duty Cycle	35% @ 200A
DC TIG Output Range	5 - 200 A
AC TIG Output Range	10 - 200 A
Stick Welding Output Range	10 - 170 A
Pulse Frequency	0.5 - 200 HZ
Pulse Width Adjustment (DC)	15 - 85 %
Weight	43 lbs.
Dimension LxWxH	19.75 in. x 9.5 in. x 16.125 in.

DESCRIPTION

The MMW240TIG is an inverter powered AC and DC TIG, Pulse TIG and Stick welder. It requires 230 VAC (196-265), 50/60 Hz input power and a 50 Amp time delayed fuse or circuit breaker. This machine comes complete with a TIG Torch, a Foot Pedal, regulator/flowmeter with inert gas hose, a ground cable and clamp, and an Electrode Holder with cable.

The MMW240TIG is the ideal Stick and TIG welder for every shop. The DC stick mode allows you to stick weld when your application requires it. In the DC TIG mode you are able to TIG weld metals such as steel and stainless steel. In the AC TIG mode, you are able to TIG weld non-ferrous metals such as Aluminum. The MMW240TIG also includes an Advanced Settings section that allows you to move into advanced TIG welding including Pulse TIG and TIG sequencer control.

The advanced inverter technology that powers the MMW240TIG provides for better arc control, lower power consumption, in a lighter more portable unit.

KNOW YOUR WELDER



FRONT PANEL CONTROLS

See the next section for a complete description of the front panel controls.

INERT GAS REGULATOR/FLOWGAUGE

Installs directly on the shielding gas cylinder. Required for TIG welding. The regulator controls the compressed gas and allows you to adjust the flow rate of the gas.

INERT GAS HOSE

The gas hose connects to the regulator/flow gauge and delivers the shielding gas from the shielding gas bottle to the welder.

GROUND CABLE AND CLAMP

The ground cable and clamp are attached to the work piece to complete the circuit allowing the flow of current needed to weld.

STYLE 17 TIG TORCH

The TIG torch transfers welding power from the welding power source to the tungsten for the purpose of TIG welding. It also delivers the shielding gas from the welding power source to the welding zone. This style 17 torch uses the same common parts as other Style 17 TIG torches.

FOOT PEDAL

The foot pedal is used to start the arc and manually adjust the amperage while TIG welding. The cord will attached to the 5-Pin connector on the back of the unit.

TIG TORCH ACCESSORIES

The TIG torch for this welder comes installed with a collet, collet body, shielding cup and short back cap. The accessory kit includes the long back cap and additional collet, collet body and shielding cups for various applications. These common parts can be used on other 17 style TIG torches.

FRONT PANEL CONTROLS

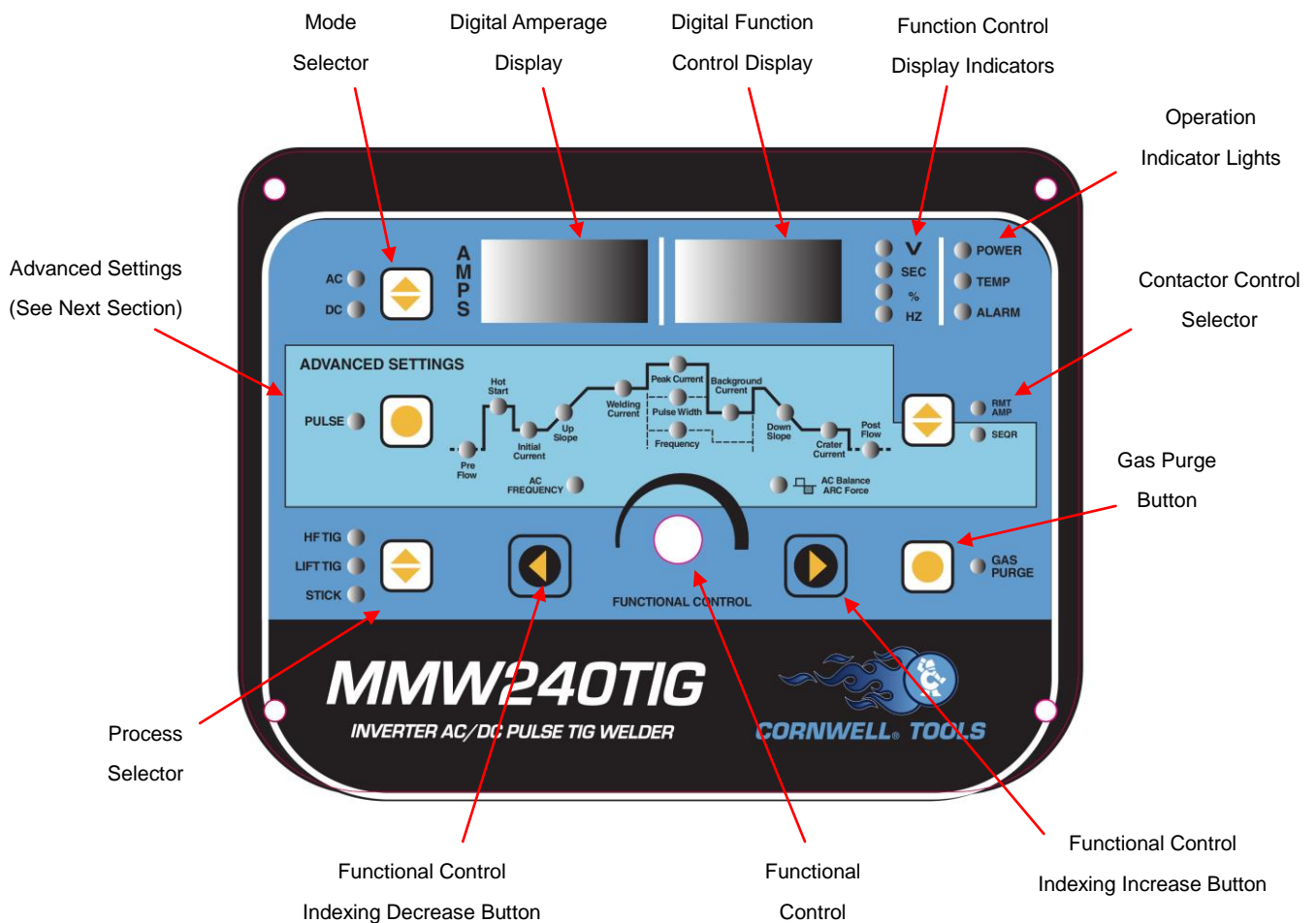

MODE SELECTOR

Use this button to choose between AC or DC welding output. The indicator lights to the left of the Mode Selector will then indicate which mode the welder is in. Note that this unit will only stick weld in the DC Mode and will automatically switch to DC when switching to STICK mode.

DIGITAL AMPERAGE DISPLAY

This display will indicate the set amperage while not welding and the actual amperage while welding.

DIGITAL FUNCTION CONTROL DISPLAY

When using the function control, this display will indicate the set value that relates to the Functional Control Display Indicator that is illuminated.

FUNCTION CONTROL DISPLAY INDICATORS

Use the Functional Control Indexing Button to illuminate the Function Control Display Indicator light that relates to the setting you wish to set. The value will then be displayed in the Digital Functional Control Display.

POWER INDICATOR LIGHT

In the "OFF" position no power is being supplied to the unit. In the "ON" position power is supplied to the main transformer and control circuit.

TEMPERATURE (TEMP) INDICATOR LIGHT

This Temperature Indicator Light will be illuminated when the welder's internal temperature has exceeded safe operating levels. Leave the unit on and allow 15 minutes for cool down before the light will go off and the temperature to fall into an allowable operating range.

ALARM INDICATOR LIGHT

The Alarm Indicator Light will be illuminated when the input voltage is either too high or too low.

CONTACTOR CONTROL SELECTOR

Push the Contactor Control Selector button to choose Remote Amp when you are using a foot pedal for remote amperage control. Push the button to choose Sequencer when you are using the push button control with the sequencer.

GAS PURGE BUTTON

Use the Gas Purge button to push the inert gas through the TIG welding torch without energizing the torch. This function helps to charge your gas lines to prepare for TIG welding. This function is only operational in either HF TIG or LIFT TIG processes.

FUNCTIONAL CONTROL INDEXING BUTTONS

Use the Functional Control Indexing Buttons to move from one control setting to another. An indicator light will then illuminate showing which function you are setting when turning the Functional Control.

FUNCTIONAL CONTROL

Use the Functional Control dial to increase and decrease the value of the function you are setting. An indicator light will then illuminate showing which function you are setting.

PROCESS SELECTOR

Use the Process Selector Button to choose the welding process. The indicator lights to the left of the button will illuminate to show which process is selected.

ADVANCED SETTINGS

Refer to the next section for detailed explanations of the Advanced Settings.

ADVANCED SETTINGS

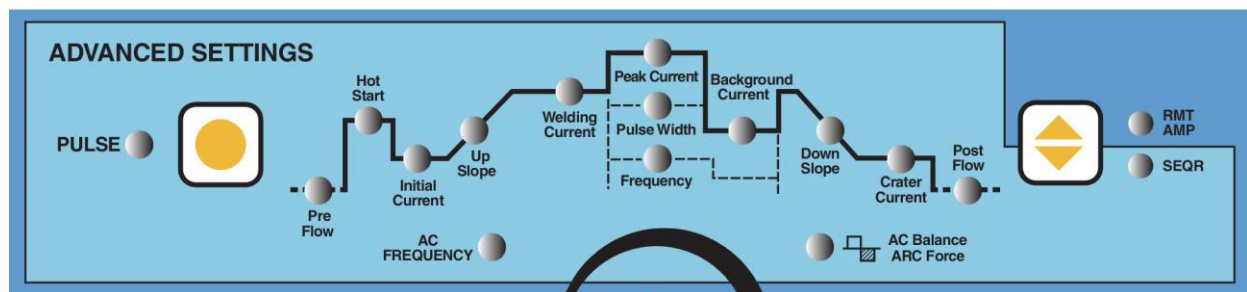

PULSE ON PUSH BUTTON

Use this button to turn the pulsing feature on or off. When the indicator light next to PULSE is on, the pulser is on. This function is only operational in either HF TIG or LIFT TIG processes. Pulse TIG welding can increase travel speed while minimizing excessive penetration.

PREFLOW INDICATOR LIGHT

In the TIG mode only, and when the SEQR indicator light is on, use one of the FUNCTIONAL CONTROL INDEX BUTTONS to turn on the preflow indicator light. The FUNCTIONAL CONTROL KNOB can then be used to increase or decrease the amount of gas preflow time during your sequenced weld. The functional control display indicator light SEC will be on indicating the set value in the Digital Functional Control Display. This feature provides gas to the welding zone prior to the arc starting to ensure a good welding environment. This function is only operational in the HF TIG processes.

HOT START INDICATOR LIGHT

In the stick mode only, use one of the FUNCTIONAL CONTROL INDEX BUTTONS to turn on the HOT START indicator light. The functional control knob can then be used to increase or decrease the hot start amperage setting as indicated on the Digital Amperage Display. Hot Start that is increased will generally result in better arc starting on hard to start electrodes.

INITIAL CURRENT INDICATOR LIGHT

In the TIG mode only, and when the SEQR indicator light is on, use one of the FUNCTIONAL CONTROL INDEX BUTTONS to turn on the INITIAL CURRENT indicator light. The FUNCTIONAL CONTROL KNOB can then be used to increase or decrease the starting amperage setting, as indicated in the Digital Amperage Display, for your sequenced weld. This setting helps to establish an arc. During a sequenced weld, this amperage setting will remain constant until you activate the upslope with the remote control.

UPSLOPE INDICATOR LIGHT

In the TIG mode only, and when the SEQR indicator light is on, use one of the FUNCTIONAL CONTROL INDEX BUTTONS to turn on the UP SLOPE indicator light. The FUNCTIONAL CONTROL KNOB can then be used to increase or decrease the amount of time it takes to go from initial current to welding current during your sequenced weld. The functional control display indicator light SEC will be on indicating the set value in the Digital Functional Control Display. This setting helps to establish a smooth transition between the initial current and the welding current.

WELDING CURRENT INDICATOR LIGHT

Use one of the FUNCTIONAL CONTROL INDEX BUTTONS until the WELDING CURRENT indicator light is on. The FUNCTIONAL CONTROL KNOB can then be used to increase or decrease the welding amperage setting, as indicated in the Digital Amperage Display. During a sequenced weld, this amperage setting will remain constant until you activate the down slope with the remote control. The Welding Current Setting is not used in Pulse TIG. Peak Current will be set in Pulse TIG.

PEAK CURRENT INDICATOR LIGHT

In the TIG mode only, when the PULSE indicator light is on, use one of the FUNCTIONAL CONTROL INDEX BUTTONS to turn on the PEAK CURRENT indicator light.

The functional control knob can then be used to increase or decrease the peak amperage setting, as indicated in the Digital Amperage Display. Peak amperage can be used in the pulse mode using the remote foot pedal or when performing a sequenced weld.

NOTE: When using a foot pedal, Peak Current is not preset. The Peak Current is controlled by the foot pedal. While welding, depress the foot pedal more to increase the Peak Current. Or, let up on the foot pedal to decrease Peak Current.

PULSE WIDTH INDICATOR LIGHT

In the TIG mode only, when the PULSE indicator light is on, use one of the FUNCTIONAL CONTROL INDEX BUTTONS to turn on the PULSE WIDTH indicator light. The functional control knob can then be used to increase or decrease the pulse width setting. The functional control display indicator light % will be on indicating the set value in the Digital Functional Control Display. Pulse width can be used in the pulse mode using the remote foot pedal or when performing a sequenced weld. In general, a higher Pulse Width % will result in a hotter weld, making the puddle more fluid and increasing penetration. Reduce this setting if burn-through is occurring.

FREQUENCY INDICATOR LIGHT

In the TIG mode only, when the PULSE indicator light is on, use one of the FUNCTIONAL CONTROL INDEX BUTTONS to turn on the FREQUENCY indicator light. The functional control

knob can then be used to increase or decrease the pulse frequency setting. The functional control display indicator light HZ will be on indicating the set value in the Digital Functional Control Display. Pulse frequency can be used in the pulse mode using the remote foot pedal or when performing a sequenced weld. In general, a higher Frequency setting will result in a narrower arc and increased penetration.

BACKGROUND CURRENT INDICATOR LIGHT

In the TIG mode only, when the PULSE indicator light is on, use one of the FUNCTIONAL CONTROL INDEX BUTTONS to turn on the BACKGROUND CURRENT indicator light. The functional control knob can then be used to increase or decrease the background amperage setting, as indicated in the Digital Amperage Display. Peak amperage can be used in the pulse mode using the remote foot pedal or when performing a sequenced weld.

DOWNSLOPE INDICATOR LIGHT

In the TIG mode only, and when the SEQR indicator light is on, use one of the FUNCTIONAL CONTROL INDEX BUTTONS to turn on the DOWN SLOPE indicator light. The FUNCTIONAL CONTROL KNOB can then be used to increase or decrease the amount of time it takes to go from initial current to welding current during your sequenced weld. The functional control display indicator light SEC will be on indicating the set value in the Digital Functional Control Display. This setting helps to establish a smooth transition between the welding current and the crater current.

CRATER CURRENT INDICATOR LIGHT

In the TIG mode only, and when the SEQR indicator light is on, use one of the FUNCTIONAL CONTROL INDEX BUTTONS to turn on the INITIAL CURRENT indicator light. The FUNCTIONAL CONTROL KNOB can then be used to increase or decrease the crater amperage setting, as indicated in the Digital Amperage Display, for your sequenced weld. This Crater Current setting helps to establish an amperage setting that can be used in conjunction with Down Slope to eliminate a crater hole at the end of your sequenced weld. During a sequenced weld, this amperage setting will remain constant until you active the postflow with the remote control.

POSTFLOW INDICATOR LIGHT

In the TIG mode only, and when the SEQR indicator light is on, use one of the FUNCTIONAL CONTROL INDEX BUTTONS to turn on the postflow indicator light. The FUNCTIONAL CONTROL KNOB can then be used to increase or decrease the amount of gas postflow time during your sequenced weld. The functional control display indicator light SEC will be on indicating the set value in the Digital Functional Control Display. This feature provides gas to the welding zone after your weld is complete, ensuring a good environment for the molten metal to solidify. Be certain to keep your torch in place until the post flow is complete.

AC FREQUENCY INDICATOR LIGHT

In the AC TIG mode only, use one of the FUNCTIONAL CONTROL INDEX BUTTONS to turn on the AC FREQUENCY indicator light. The functional control knob can then be used to increase or decrease the AC frequency setting. The functional control display indicator light HZ will be on indicating the set value in the Digital Functional Control Display. AC frequency can be used in the pulse mode using the remote foot pedal or when performing a sequenced weld. Increase AC frequency to create a narrower arc and penetration pattern. Decrease AC frequency to create a wider arc with shallow penetration.

AC BALANCE/ARC FORCE INDICATOR LIGHT

AC BALANCE: In the AC TIG mode only, use one of the FUNCTIONAL CONTROL INDEX BUTTONS to turn on the AC BALANCE/ARC FORCE indicator light. The functional control knob can then be used to increase or decrease the AC BALANCE setting. The functional control display indicator light % will be on indicating the set value in the Digital Functional Control Display. AC

balance can be used in the pulse mode using the remote foot pedal or when performing a sequenced weld. Increase AC balance when the material you are welding has a higher amount of oxidation and more cleaning is needed during the weld. Be mindful that increasing the AC balance will also create a wider arc with shallower penetration. Decrease AC balance when the material you are welding has less oxidation and less cleaning is needed during the weld. Be mindful that decreasing the AC balance will also create a narrower arc with deeper penetration.

ARC FORCE: In the stick mode only, use one of the FUNCTIONAL CONTROL INDEX BUTTONS to turn on the AC BALANCE/ARC FORCE indicator light. The functional control knob can then be used to increase or decrease the ARC FORCE setting. The functional control display indicator light % will be on indicating the set value in the Digital Functional Control Display. Arc Force that is increased will generally result in a more forceful arc, increasing penetration when in the STICK mode and preventing arc outages due to the electrode shorting out to the workpiece. Arc Force that is decreased will generally result in a less forceful arc, decreasing penetration when in the STICK mode. This control may be useful with materials you are welding are not perfectly fit together or if you are in awkward positions and maintaining the proper arc length is difficult.

INSTALLATION

1. POWER REQUIREMENT - AC single phase 230V, 50/60 HZ with a 50 amp circuit breaker is required. DO NOT OPERATE THIS UNIT if the ACTUAL power source voltage is less than 196 volts AC or greater than 265 volts AC.

▲ WARNING

- **High voltage danger from power source! Consult a qualified electrician for proper installation of receptacle. This welder must be grounded while in use to protect the operator from electrical shock.**
- **Do not remove grounding prong or alter the plug in any way. Do not use any adapters between the welder's power cord and the power source receptacle. Make sure the POWER switch is OFF when connecting your welder's power cord to a properly grounded 230 VAC, 50/60 HZ, Single Phase, 50 Amp input power supply.**

2. EXTENSION CORD - We do not recommend an extension cord because of the voltage drop they produce. This drop in voltage can affect the performance of the welder. If you need to use an extension cord, we recommend you check with a qualified electrician and your local electrical codes for your specific area. Do not use an extension cord over 25 ft. in length.

3. STICK WELDING CONNECTION – DC Stick welding is generally performed DC Electrode Positive. That means that the electrode holder and cable would be attached to the Positive (+) weld output connection and the ground cable and clamp would be attached to the Negative (-) weld output connection.

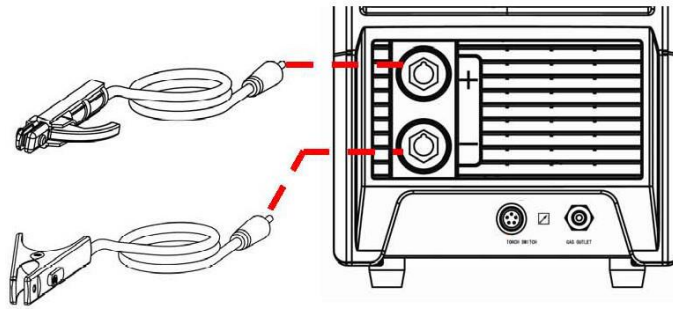

4. TIG WELDING CONNECTION – DC TIG welding is generally performed DC Electrode negative. That means that the TIG torch and cable would be attached to the Negative (-) weld output connection and the ground cable and clamp would be attached to the Positive (+) weld output connection. Use this same connection when AC TIG welding.

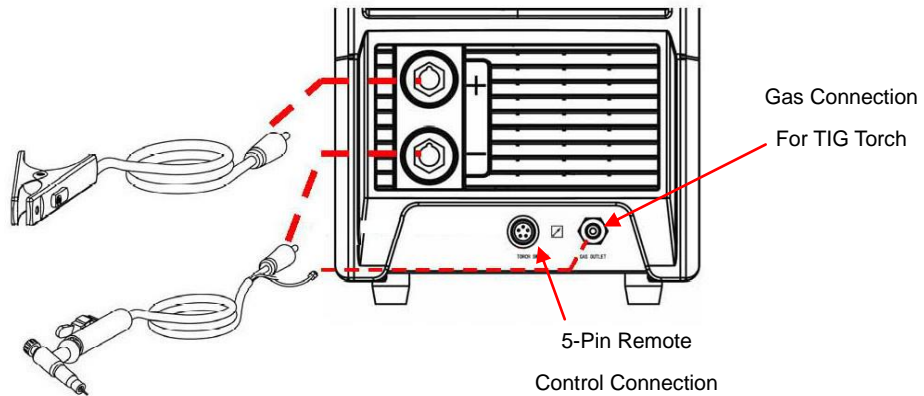

6. BACK PANEL CONNECTIONS

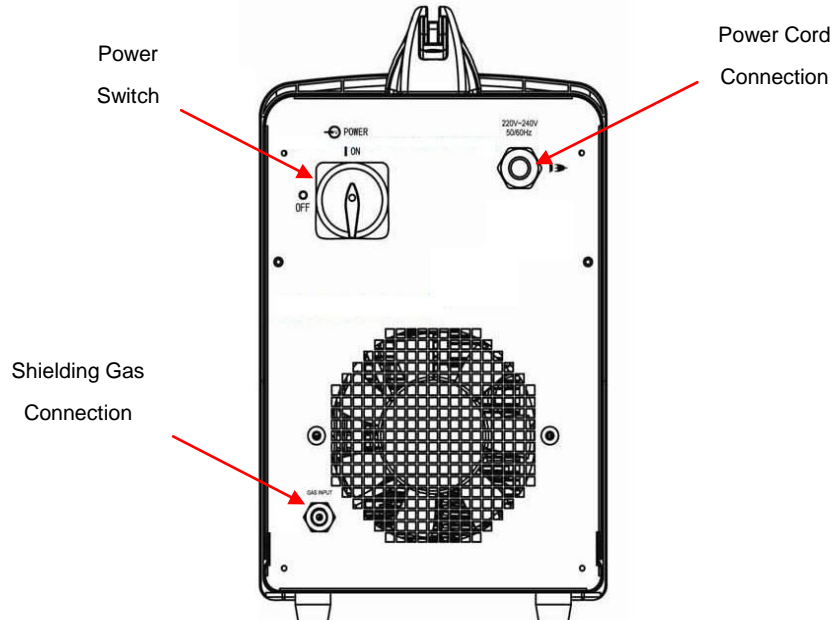

7. GAS INSTALLATION

▲ WARNING

Shielding gas cylinders and high pressure cylinders can explode if damaged, so treat them carefully.

- Never expose cylinders to high heat, sparks, open flames, mechanical shocks or arcs.
- Do not weld on the cylinder.

- **Always secure cylinder upright to a cart or stationary object.**
- **Keep cylinders away from welding or electrical circuits.**
- **Use the proper regulators, gas hose and fittings for the specific application.**

7.1. Connect one end of the gas hose to the gas hose connection on the back of the welder. Use a wrench to snug up the connection.

7.2. Connect the other end of the gas hose to the gas hose connection on the supplied regulator/flowgauge. Use a wrench to snug up the connection.

7.3. Before installing the regulator, it is good practice to make certain no debris is in the gas bottle connection. Rotate the bottle so the gas connection is not pointing toward you or any other person. Turn the valve on the gas bottle clockwise and quickly close. This quick thrust of gas will clear any debris in the connection. Connect the regulator to the gas bottle connection. Use a wrench to snug up the connection.

- (1) Gas Bottle Valve
- (2) Gas Flow Gauge (Set at 20 CFH)
- (3) Gas Pressure Gauge
- (4) Regulator
- (5) Gas Flow Adjuster
- (6) Gas Hose
- (7) Gas Cylinder

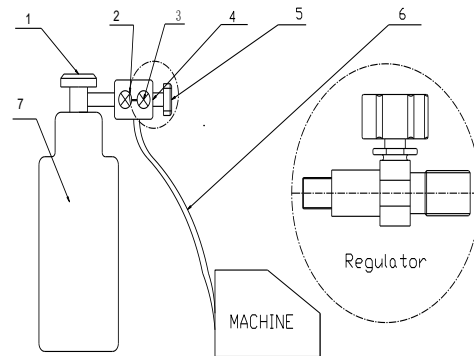

7.4. Open the Gas Bottle Valve on the cylinder of gas.

7.5. Turn the Gas Flow Adjuster on the regulator so that the gas flow rate is set at approximately 20 CFH. Make certain you are reading the correct scale on the gauge.

NOTE: Slowly open the cylinder valve by turning it counterclockwise until the cylinder pressure gauge registers on the first gauge of the regulator. Turn the adjustment knob clockwise (right) slowly to increase gas flow to 20 cfh. To reduce the gas flow turn the adjustment counterclockwise (left). The gas valve is located on the back panel of the welder and activated by the foot pedal or gas purge button.

7.6. Gas selection – Except for very specialized TIG welding applications, TIG welding can be done with 100% Argon. Consult your gas supplier for more information.

8. REMOTE CONTROL INSTALLATION

NOTE: When stick welding, remove all remote controls. Failure to do this will result in minimal welding output only.

8.1 Remote Contactor Only – A push button control is included with this machine. The push button can be used in two applications

- 8.1.a – Contactor Control – Use the push button control in the TIG mode to turn the arc on only. When using the push button for this purpose, the amperage will be set on the front panel and will not vary during the weld.

8.1.b – Sequencer Control – Use the push button control in the TIG mode when using the sequencer. Push the push button to initiate the arc and then push it again to advance to the next step in the sequencer.

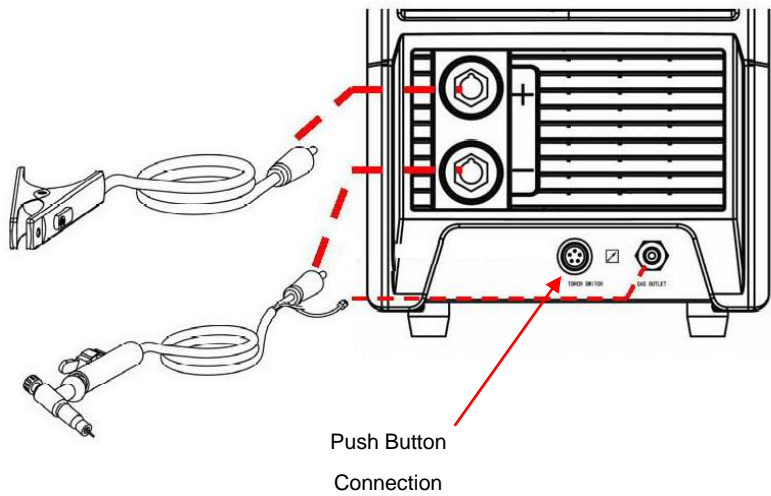

8.2 Remote Contactor And Amperage Control – This unit comes standard with a remote foot pedal control. The remote foot pedal is used to initiate the arc and then vary the amperage during your weld. Connect the remote foot pedal control to the Foot Pedal Connection on the lower front panel.

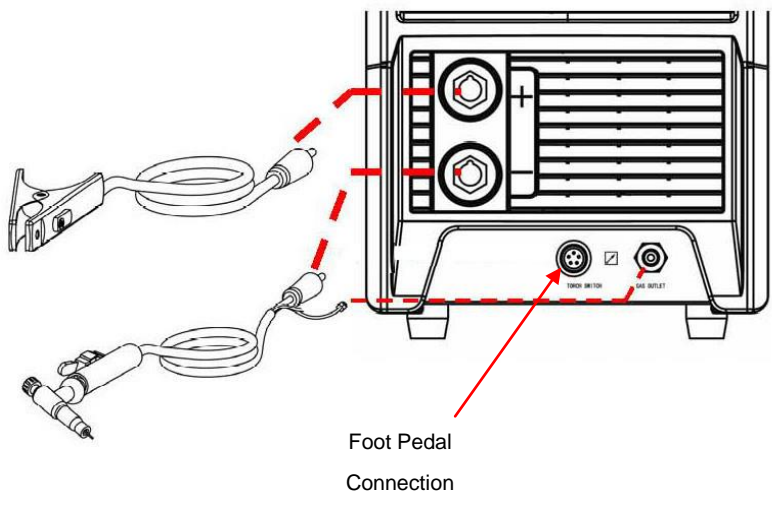

PRE OPERATION SET-UP

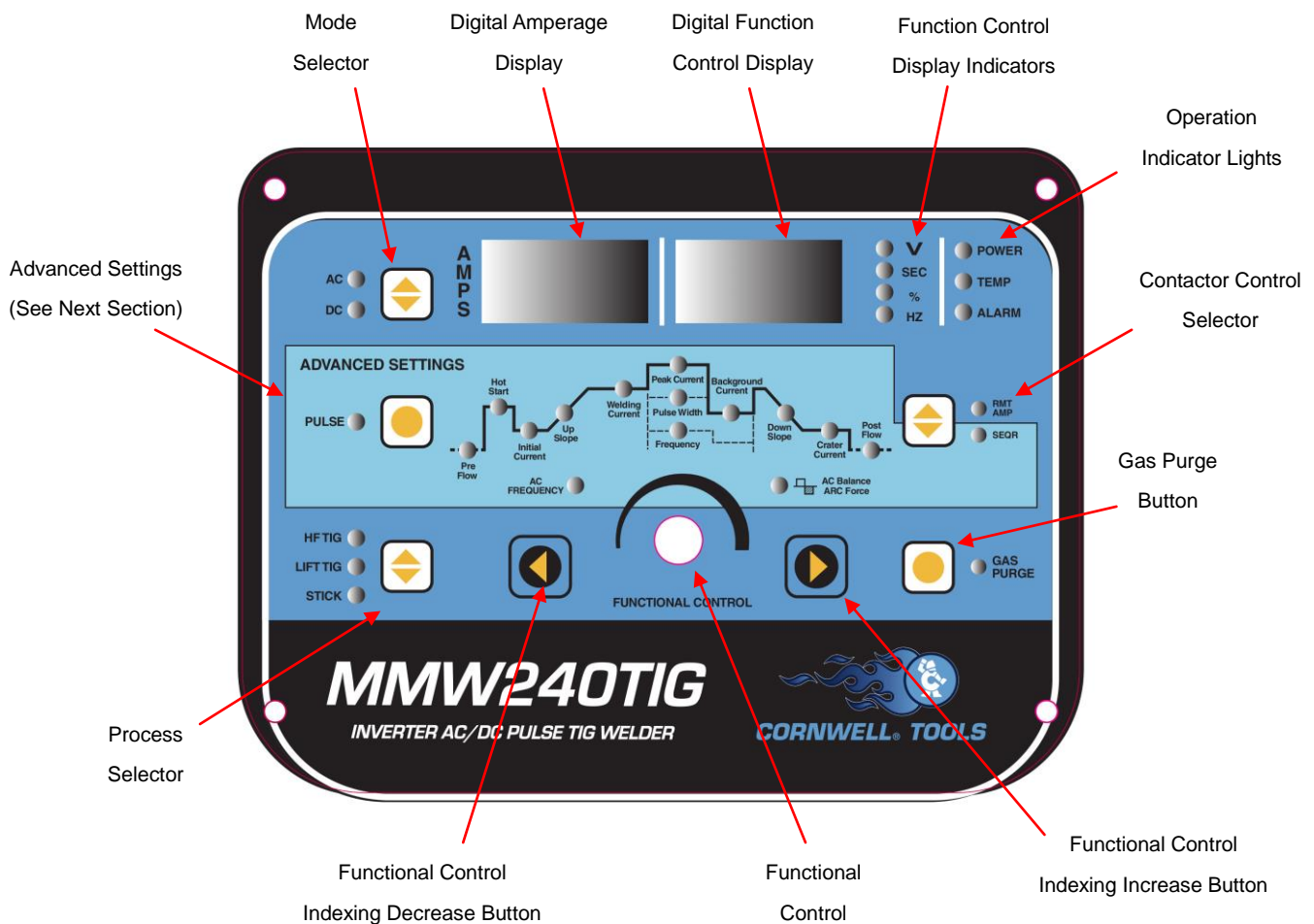

1. SET UP INSTRUCTIONS FOR DC STICK ELECTRODE WELDING

- Connect the stick electrode holder to the POSITIVE terminal on the front of the machine (See item 3 of the INSTALLATION section).
- Connect the ground cable to the NEGATIVE terminal on the front of the machine (See item 3 of the INSTALLATION section).
- Connect the primary power cable to 230 volt AC single phase electricity.
- Turn on the machine using switch on the back of the machine.
- Use the PROCESS SELECTOR BUTTON to Select STICK on front panel
- Use the MODE SELECTOR BUTTON on the front panel to Select DC.
- Use one of the FUNCTIONAL CONTROL INDEX BUTTONS until the WELDING CURRENT indicator light is on. Use the FUNCTIONAL CONTROL KNOB to select preferred welding current as displayed on the Digital Amperage Display. Example: Set weld current at 150 or adjust current according to the size of electrode.
- To set ARC Force, use one of the FUNCTIONAL CONTROL INDEX BUTTONS until the AC BALANCE/ARC FORCE indicator light is on. Use the FUNCTIONAL CONTROL KNOB to select the preferred arc force setting as displayed on the Digital Functional Control Display.
- To set HOT START, use one of the FUNCTIONAL CONTROL INDEX BUTTONS until the HOT START indicator light is on. Use the FUNCTIONAL CONTROL KNOB to select the preferred Hot Start setting as displayed on the Digital Amperage Display.

The machine is now set up to STICK weld using DC output.

2. SET UP INSTRUCTIONS FOR DC TIG WELDING

- Connect TIG torch to the NEGATIVE terminal on the front of the machine (See item 4 of the INSTALLATION section).
- Connect the ground cable to the POSTIVE terminal on the front of the machine (See item 4 of the INSTALLATION section).
- Connect the Argon regulator securely to the cylinder. Secure and tighten one end of hose to regulator, and the other end to the gas fitting on the rear of the welding machine. Slowly open valve on cylinder. (See items 6 and 7 of the INSTALLATION section).
- Connect foot control to 5-pin receptacle on the lower front panel. (See item 8 of the INSTALLATION section).
- Connect the primary power cable to 230 volt AC single phase electricity.
- Turn on the machine using switch on the back of the machine (See item 6 of the INSTALLATION section).
- Use the PROCESS SELECTOR BUTTON to Select HF TIG on front panel
- Use the MODE SELECTOR BUTTON on the front panel to Select DC.
- Use the CONTACTOR CONTROL BUTTON TO Select RMT AMP position on front panel
- Use one of the FUNCTIONAL CONTROL INDEX BUTTONS until the PRE FLOW indicator light is on. Use the FUNCTIONAL CONTROL KNOB to select the preferred seconds of pre flow as displayed on the Digital Functional Control Display. Example: Set Pre Flow to 3 SEC. The purpose of pre flow is to cover the welding zone with shielding gas prior to the arc start. This generally is a short setting. Hold the TIG torch steady during pre flow.
- Use one of the FUNCTIONAL CONTROL INDEX BUTTONS until the POST FLOW indicator light is on. Use the FUNCTIONAL CONTROL KNOB to select the preferred seconds of post flow as displayed on the Digital Functional Control Display. Example: Set Post Flow to 10 SEC.
- NOTE: Adjust the gas flow rate using the adjustable knob on the regulator. (See item 7 of the INSTALLATION section). Depress the foot pedal and set the flow rate at approximately 20 CFH. With foot pedal depressed Open and Adjust the flow control valve on the regulator to approximately 20 CFH. Release foot pedal.

Machine is now set up to TIG weld using DC output.

3. SET UP INSTRUCTIONS FOR AC TIG WELDING

- Connect TIG torch to the NEGATIVE terminal on the front of the machine (See item 4 of the INSTALLATION section).
- Connect the ground cable to the POSTIVE terminal on the front of the machine (See item 4 of the INSTALLATION section).
- Connect the Argon regulator securely to the cylinder. Secure and tighten one end of hose to regulator, and the other end to the gas fitting on the rear of the welding machine. Slowly open valve on cylinder. (See items 6 and 7 of the INSTALLATION section).
- Connect foot control to 5-pin receptacle on the lower front panel. (See item 8 of the INSTALLATION section).
- Connect the primary power cable to 230 volt AC single phase electricity.
- Turn on the machine using switch on the back of the machine (See item 6 of the INSTALLATION section).

- Use the PROCESS SELECTOR BUTTON to Select HF TIG on front panel
- Use the MODE SELECTOR BUTTON on the front panel to Select AC.
- Use the CONTACTOR CONTROL BUTTON TO Select RMT AMP position on front panel.
- Use one of the FUNCTIONAL CONTROL INDEX BUTTONS until the PRE FLOW indicator light is on. Use the FUNCTIONAL CONTROL KNOB to select the preferred seconds of pre flow as displayed on the Digital Functional Control Display. Example: Set Pre Flow to 3 SEC. The purpose of pre flow is to cover the welding zone with shielding gas prior to the arc start. This generally is a short setting. Hold the TIG torch steady during pre flow.
- Use one of the FUNCTIONAL CONTROL INDEX BUTTONS until the AC FREQUENCY indicator light is on. Use the FUNCTIONAL CONTROL KNOB to select the preferred AC frequency as displayed on the Digital Functional Control Display. Example: Set AC Frequency to 100 Hz.
- Use one of the FUNCTIONAL CONTROL INDEX BUTTONS until the AC BALANCE indicator light is on. Use the FUNCTIONAL CONTROL KNOB to select the preferred percentage as displayed on the Digital Functional Control Display. Example: Set AC Balance to 65%.

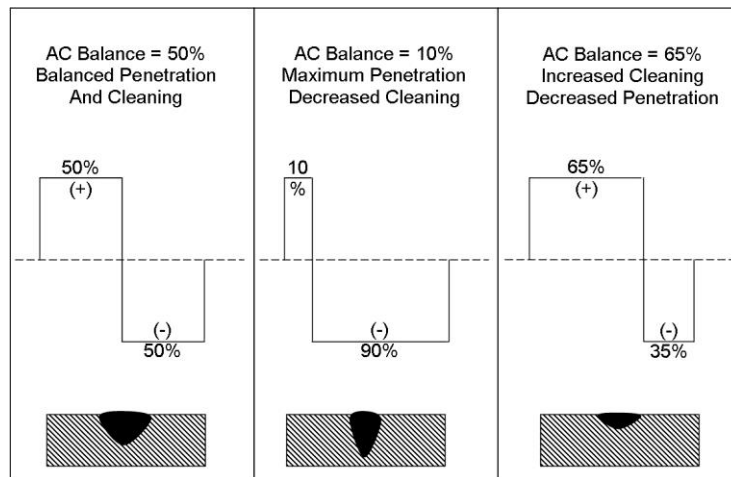

- Use one of the FUNCTIONAL CONTROL INDEX BUTTONS until the POST FLOW indicator light is on. Use the FUNCTIONAL CONTROL KNOB to select the preferred seconds of post flow as displayed on the Digital Functional Control Display. Example: Set Post Flow to 10 SEC.
- NOTE: Adjust the gas flow rate using the adjustable knob on the regulator. (See item 7 of the INSTALLATION section). Depress the foot pedal and set the flow rate at approximately 20 CFH. With foot pedal depressed Open and Adjust the flow control valve on the regulator to approximately 20 CFH. Release foot pedal.

Machine is now set up to TIG weld using AC output.

PULSE TIG SET-UP

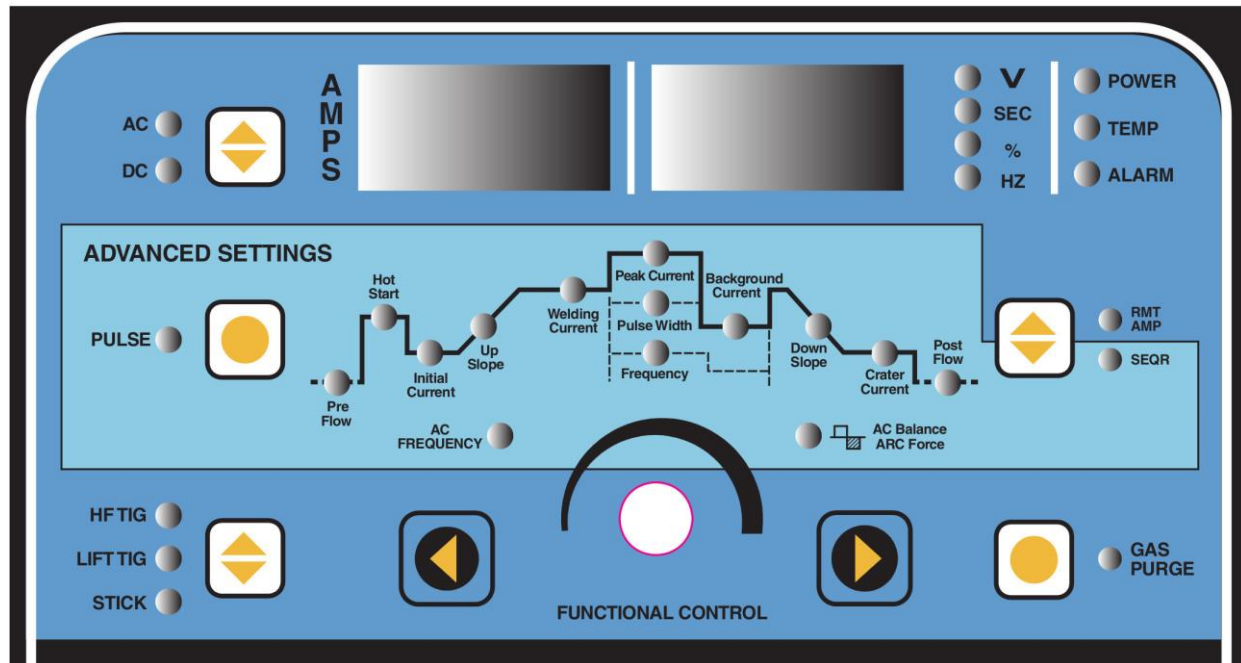

1. Follow the TIG welding set-up in the previous section.
2. For Manual Pulse TIG, using a foot pedal, set the CONTACTOR CONTROL SELECTOR so that the RMT AMP light is on. See the next section for sequencer set-up.
3. Use one of the FUNCTIONAL CONTROL INDEX BUTTONS until the PRE FLOW indicator light is on. Use the FUNCTIONAL CONTROL KNOB to select the preferred seconds of pre flow as displayed on the Digital Functional Control Display. Example: Set Pre Flow to 3 SEC. The purpose of pre flow is to cover the welding zone with shielding gas prior to the arc start. This generally is a short setting. Hold the TIG torch steady during pre flow.
4. Use one of the FUNCTIONAL CONTROL INDEX BUTTONS until the PEAK CURRENT indicator light is on.
NOTE: When using a foot pedal, Peak Current is not preset. The Peak Current is controlled by the foot pedal. While welding, depress the foot pedal more to increase the Peak Current. Or, let up on the foot pedal to decrease Peak Current. Practice with Peak Current. Try a sample run on scrap metal. Then try increasing or decreasing the Peak Current and see what it does to the weld puddle. In general, a higher Peak Current will result in more penetration.
5. Use one of the FUNCTIONAL CONTROL INDEX BUTTONS until the PULSE WIDTH indicator light is on. Use the FUNCTIONAL CONTROL KNOB to select the preferred Pulse Width as displayed on the Digital Function Control Display. Example: Set Pulse Width to 50%. The Pulse Width is the percentage of time the machine stays on the Peak Current. Practice with this setting. Try a sample run on scrap metal. Then try increasing or decreasing the Pulse Width and see what it does to the weld puddle. In general, a higher Pulse Width % will result in a hotter weld, making the puddle more fluid and increasing penetration. Reduce this setting if burn-through is occurring.
6. Use one of the FUNCTIONAL CONTROL INDEX BUTTONS until the FREQUENCY

indicator light is on. Use the FUNCTIONAL CONTROL KNOB to select the preferred Pulse Frequency as displayed on the Digital Function Control Display. Example: Set Pulse Frequency to 1. The Pulse Frequency is the number of times per second that the machine changes from Peak Current to Back Ground Current. Practice with this setting. Try a sample run on scrap metal. Then try increasing or decreasing the Pulse Frequency and see what it does to the weld puddle and your technique. Some operators will time the introduction of filler metal at the Peak. Adjust the frequency as your skill improves.

7. Use one of the FUNCTIONAL CONTROL INDEX BUTTONS until the BACKGROUND CURRENT indicator light is on. Use the FUNCTIONAL CONTROL KNOB to select the preferred background amperage as displayed on the Digital Amperage Display. Example: Set Background Current to 50 Amps. The Background Current is the amperage the machine will pulse down to, providing a reduction of power to pause penetration and to prevent burn-through. Practice with this setting. Try a sample run on scrap metal. Then try increasing or decreasing the Background Current and see what it does to the weld puddle. In general, a Background Current should be set high enough to keep the weld puddle fluid but low enough to prevent burn-through.
8. Use one of the FUNCTIONAL CONTROL INDEX BUTTONS until the POST FLOW indicator light is on. Use the FUNCTIONAL CONTROL KNOB to select the preferred seconds of post flow as displayed on the Digital Functional Control Display. Example: Set Post Flow to 10 SEC. The purpose of post flow is to cover the welding zone with shielding gas preventing contamination while the arc is off and the weld puddle cools. Hold the TIG torch steady over the end of the puddle during post flow.
9. Your machine is now set for Pulse welding.
10. Use the Foot Pedal to start the arc and vary amperage as you are welding.

TIG SEQUENCER SET-UP

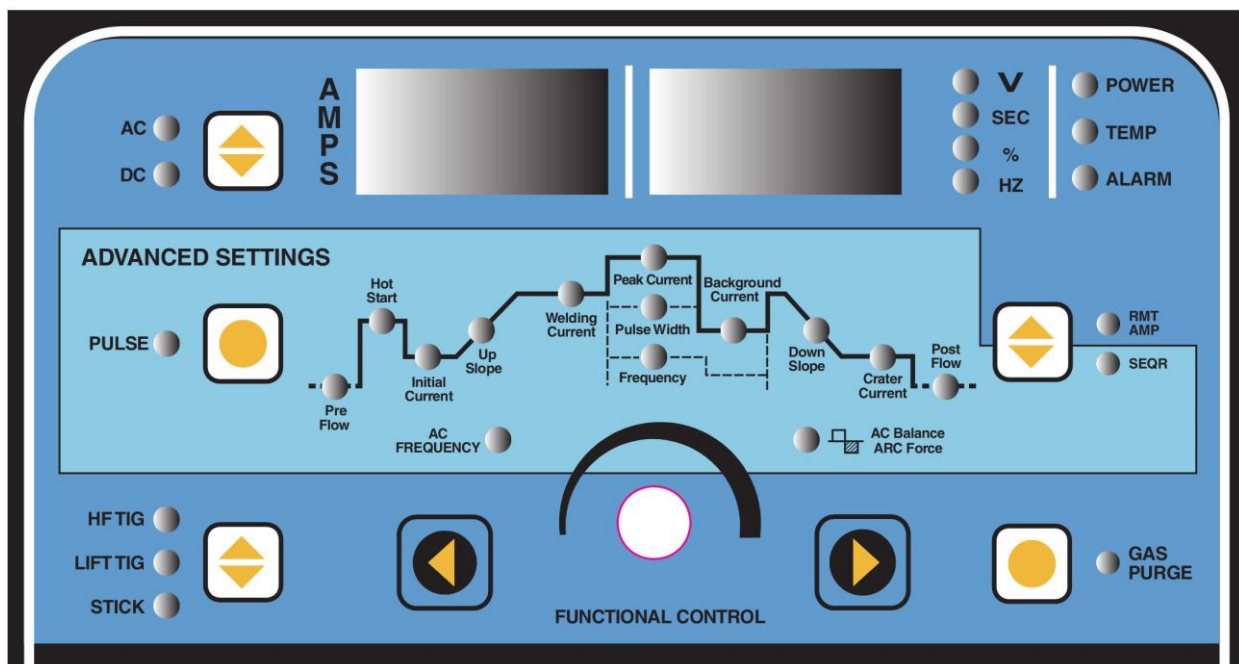

1. Follow the TIG welding set-up in the previous sections.

NOTE: Using a sequencer will be more successful for DC TIG applications. Amperage controls are limited to set values in the sequencer. AC TIG applications usually require more amperage flexibility.

2. Follow the Pulse TIG set-up in the previous section if you decide to use pulse TIG in conjunction with the sequencer.
3. Remove the foot pedal that may be installed in the 5-Pin Remote Amperage connection on the lower front panel. Install the Remote Push Button Control to the 5-Pin Connector on the front of the machine. (See Step 8.1b in the INSTALLATION section).
4. Use one of the FUNCTIONAL CONTROL INDEX BUTTONS until the INITIAL CURRENT indicator light is on. Use the FUNCTIONAL CONTROL KNOB to select the preferred INITIAL amperage as displayed on the Digital Amperage Display. Example: Set Initial Current to 20 Amps. This Initial Current helps to establish an arc. During a sequenced weld, this amperage setting will remain constant until you activate the upslope with the remote control.
5. Use one of the FUNCTIONAL CONTROL INDEX BUTTONS until the UP SLOPE indicator light is on. Use the FUNCTIONAL CONTROL KNOB to select the preferred Up Slope time as displayed on the Digital Function Control Display. Example: Set Up Slope to 2 SEC. This Up Slope setting helps to establish a smooth transition between the initial current and the welding current (Peak Current when in the Pulse TIG mode).
6. Use one of the FUNCTIONAL CONTROL INDEX BUTTONS until the PEAK CURRENT indicator light is on (If Using PULSE). Use the FUNCTIONAL CONTROL KNOB to select the preferred peak amperage as displayed on the Digital Amperage Display. Example: Set Peak Current to 150 Amps. The Peak Current is the amperage the machine will pulse up to, providing a burst of power to increase penetration. Practice with this setting. Try a sample run on scrap metal. Then try increasing or decreasing the Peak Current and see what it does to the weld puddle. In general, a higher Peak Current will result in more penetration.
7. Use one of the FUNCTIONAL CONTROL INDEX BUTTONS until the DOWN SLOPE indicator light is on. Use the FUNCTIONAL CONTROL KNOB to select the preferred Down Slope time as displayed on the Digital Function Control Display. Example: Set Down Slope to 2 SEC. This Down Slope setting helps to establish a smooth transition between the welding current and the crater current.
8. Use one of the FUNCTIONAL CONTROL INDEX BUTTONS until the CRATER CURRENT indicator light is on. Use the FUNCTIONAL CONTROL KNOB to select the preferred crater amperage as displayed on the Digital Amperage Display. Example: Set Crater Current to 20 Amps. This Crater Current setting helps to establish an amperage setting that can be used in conjunction with Down Slope to eliminate a crater hole at the end of your sequenced weld. During a sequenced weld, this amperage setting will remain constant until you active the postflow with the remote control.
9. Your machine is now set for Sequence TIG welding.
10. Use the Remote Control to start the arc and transition to the next part of the sequence as you are welding.

BASIC STICK WELDING OPERATION

▲WARNING

High voltage danger from power source! Consult a qualified electrician for proper installation of receptacle at the power source. This welder must be grounded while in use to protect the operator from electrical shock. If you are not sure if your outlet is properly grounded, have it checked by a qualified electrician. Do not cut off the grounding prong or alter the plug in any way and do not use any adapter between the welder's power cord and the power source receptacle. Make sure the POWER switch is OFF then connect your welder's power cord to a properly grounded 230 VAC, 50/60 HZ, single phase, 50 amp power source.

1. SETTING UP THE WORK PIECE

1.1 Welding positions

There are two basic positions, for welding: Flat and Horizontal. Flat welding is generally easier, faster, and allows for better penetration. If possible, the work piece should be positioned so that the bead will run on a flat surface.

1.2 Preparing the Joint

Before welding, the surface of work piece needs to be free of dirt, rust, scale, oil or paint or it will create brittle and porous welds. If the base metal pieces to be joined are thick or heavy, it may be necessary to bevel the edges with a metal grinder, the correct bevel should be around 60 degrees. See following picture:

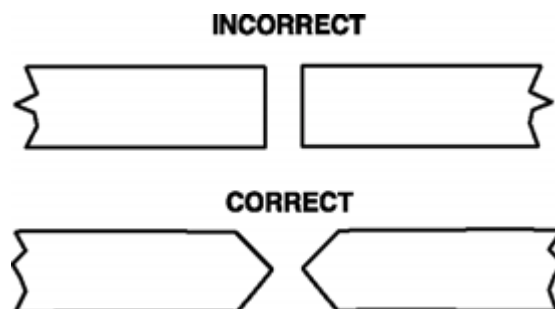

Based on different welding positions, there are different welding joints, see following images for more information.

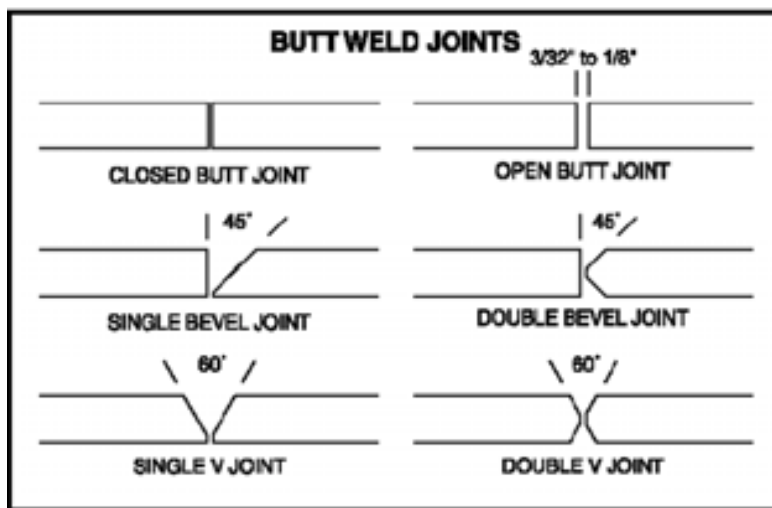

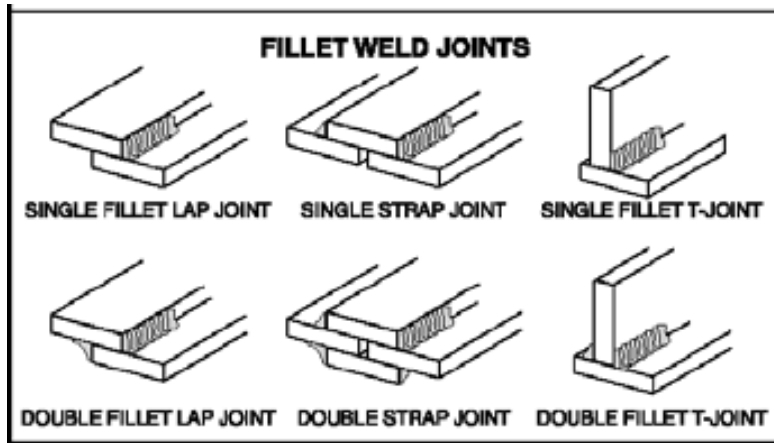

2. GROUND CLAMP CONNECTION

Clear any dirt, rust, scale, oil or paint on the ground clamp. Make certain you have a good solid ground connection. A poor connection at the ground clamp will waste power and heat. Make sure the ground clamp touches the metal.

3. ELECTRODE

The welding electrode is a rod coated with a layer of flux. When welding, electrical current flows between the electrode (rod) and the grounded metal work piece. The intense heat of the arc between the rod and the grounded metal melts the electrode and the flux.

4. SELECTING THE PROPER ELECTRODE

There is no golden rule that determines the exact rod or heat setting required for every situation. The type and thickness of metal and the position of the work piece determine the electrode type and the amount of heat needed in the welding process. Heavier and thicker metals required more amperage. It is best to practice your welds on scrap metal which matches the metal you intend to work with to determine correct heat setting and electrode choice. See the following helpful trouble shooting tips to determine if you are using a correct electrode.

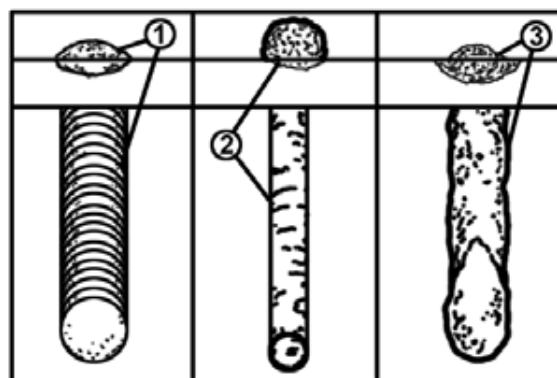

4.1. When proper rod is used:

- 4.1.a. The bead will lay smoothly over the work without ragged edges
- 4.1.b. The base metal puddle will be as deep as the bead that rises above it
- 4.1.c. The welding operation will make a crackling sound similar to the sound of eggs frying

4.2. When a rod too small is used;

- 4.2. a. The bead will be high and irregular

4.2. b. The arc will be difficult to maintain

4.3. When the rod is too large

4.3. a. The arc will burn through light metals

4.3. b. The bead will undercut the work

4.3. c. The bead will be flat and porous

4.3. d. Rod may freeze or stick to work piece

Note: Rate of travel over the work also affects the weld. To ensure proper penetration and enough deposit of rod, the arc must be moved slowly and evenly along the weld seam.

5. SETTING THE AMPERAGE CONTROL

The welder has current control that is infinitely adjustable within its range. It is capable of welding with electrodes up to 1/8" diameter. There is no golden rule that determines the exact amperage required for every situation. It is best to practice your welds on scrap metal which matches the metals you intend to work with to determine correct setting for your job. The electrode type and the thickness of the work piece metal determine the amount of heat needed in the welding process. Heavier and thicker metals require more voltage (amperage), whereas lighter and thinner metals require less voltage (amperage). Consult the welding electrode packaging for recommended welding amperage range.

6. WELDING TECHNIQUES

The best way to teach yourself how to weld is with short periods of practice at regular intervals. All practice welds should be done on scrap metal that can be discarded. Do not attempt to make any repairs on valuable equipment until you are satisfied with the appearance of your practice welds and free of slag or gas inclusions.

6.1 Holding the electrode

The best way to grip the electrode holder is the way that feels most comfortable to you. Position the Electrode to the work piece when striking the initial arc, it may be necessary to hold the electrode perpendicular to the work piece. Once the arc is started, the angle of the electrode in relation to the work piece should be between 10 and 30 degrees. This will allow for good penetration, with minimal spatter.

6.2 Striking the arc

▲WARNING

EXPOSURE TO A WELDING ARC IS EXTREMELY HARMFUL TO THE EYES AND SKIN! Prolonged exposure to the welding arc can cause blindness and burns. Never strike an arc or begin welding until you are adequately protected. Wear flame-proof welding gloves, a heavy long sleeved shirt, trousers without cuffs, high topped shoes, and an ANSI approved welding helmet.

Scratch the work piece with the end of electrode to start arc and then raise it quickly about 1/8 inch gap between the rod and the work piece. See following picture.

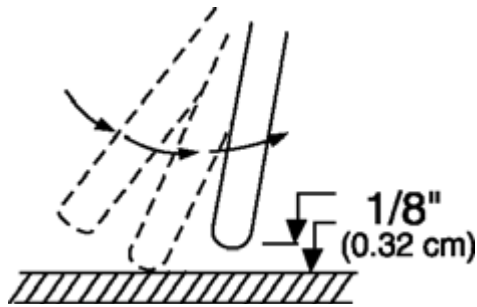

It is important that the gap be maintained during the welding process and it should be neither too wide nor too narrow. If too narrow, the rod will stick to the work piece. If too wide, the arc will be extinguished. It needs much practice to maintain the gap. The beginners may usually get stuck or arc will be extinguished. When the rod is stuck to the work piece, gently rock it back and forth to make them separate. If not, a short circuit will occur and it will break the welder. A good arc is accompanied by a crisp, cracking sound. The sound is similar to that made by eggs frying. To lay a weld bead, only 2 movements are required; downward (as the electrode is consumed) and in the direction the weld is to be laid, as in following figure:

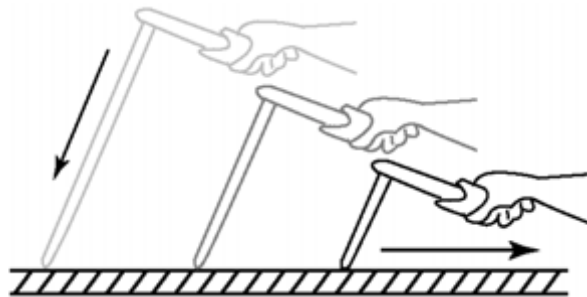

6.3 Types of weld bead

The following paragraphs discuss the most commonly used arc welding beads.

The stringer bead Formed by traveling with the electrode in a straight line while keeping the electrode centered over the weld joint.

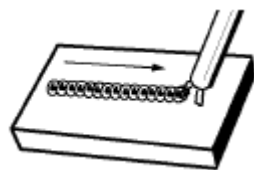

Stringer Bead

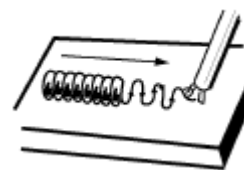

Weave Bead

The weave bead Used when you want to deposit metal over a wider space than would be possible with a stringer bead. It is made by weaving from side to side while moving with the electrode. It is best to hesitate momentarily at each side before weaving back the other way.

6.4 Welding position

Flat position It is easiest of the welding positions and is most commonly used. It is best if you can weld in the flat position if at all possible as good results are easier to achieve.



Flat Position



Horizontal Position

The horizontal position it is performed very much the same as the flat weld except that the angle is different such that the electrode, and therefore the arc force, is directed more toward the metal above the weld joint. This more direct angle helps prevent the weld puddle from running downward while still allowing slow enough travel speed to achieve good penetration. A good starting point for your electrode angle is about 30 degrees DOWN from being perpendicular to the work piece.

6.5 Judge the good weld bead

When the trick of establishing and holding an arc has been learned, the next step is learning how to run a good bead. The first attempts in practice will probably fall short of acceptable weld beads. Too long of an arc will be held or the travel speed will vary from slow to fast (see following).

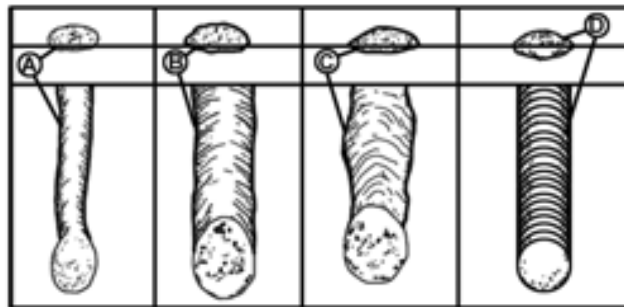

- A. Weld speed is too fast
- B. Weld speed is too slow
- C. Arc is too long
- D. Ideal weld

A solid weld bead requires that the electrode be moved slowly and steadily along the weld seam. Moving the electrode rapidly or erratically will prevent proper fusion or create a lumpy, uneven bead.

▲ WARNING

ELECTRIC SHOCK CAN CAUSE INJURY OR DEATH! To prevent ELECTRIC SHOCK, do not perform any welding while standing, kneeling, or lying directly on the grounded workpiece.

6.6 Finish the bead

As the coating on the outside of the electrode burns off, it forms an envelope of protective gases around the weld. This prevents air from reaching the molten metal and creating an undesirable chemical reaction. The burning coating, however, forms slag. The slag formation appears as an accumulation of dirty metal scale on the finished weld. Slag should be removed by using a chipping hammer.

▲ WARNING

PEENING THE SLAG FROM A WELD JOINT CAUSES SMALL CHIPS OF METAL TO FLY THROUGH THE AIR! Metallic chips flying through the air can cause eye injury or injury to other parts of the head, hands or exposed portions of the body. Wear goggles or safety glasses with side shields and protect the hands and other exposed parts of the body with protective garments, or if possible, work with a shield between the body and the work piece.

The intense heat produced at the arc sets up strains in the metal joined by welding. Peening the weld not only removes the scale left behind in the welding but relieves the internal strains developed by the heating and cooling process.

BASIC TIG WELDING OPERATION

▲ WARNING

High voltage danger from power source! Consult a qualified electrician for proper installation of receptacle at the power source. This welder must be grounded while in use to protect the operator from electrical shock. If you are not sure if your outlet is properly grounded, have it checked by a qualified electrician. Do not cut off the grounding prong or alter the plug in any way and do not use any adapter between the welder's power cord and the power source receptacle. Make sure the POWER switch is OFF then connect your welder's power cord to a properly grounded 230 VAC, 50/60 HZ, single phase, 50 amp power source.

▲ WARNING

EXPOSURE TO A WELDING ARC IS EXTREMELY HARMFUL TO THE EYES AND SKIN! Prolonged exposure to the welding arc can cause blindness and burns. Never strike an arc or begin welding until you are adequately protected. Wear flame-proof welding gloves, a heavy long sleeved shirt, trousers without cuffs, high topped shoes, and an ANSI approved welding helmet.

▲ CAUTION

Be aware that the TIG torch will be electrically LIVE when the Input Power Switch on the welder is turned on.

Gas Tungsten Arc Welding (GTAW) or TIG (Tungsten Inert Gas) as it is commonly referred to, is a welding process in which fusion is produced by an electric arc that is established between a single tungsten (non-consumable) electrode and the work piece. Shielding is obtained from a welding grade shielding gas or welding grade shielding gas mixture which is generally Argon based. A filler metal may also be added manually in some circumstances depending on the welding application.

Tungsten Electrode Current Ranges

Electrode Diameter	DC Current (Amps)
0.040" (1.0 mm)	30-60
1/16" (1.6 mm)	60-115
3/32" (2.4 mm)	100-165
1/8" (3.2mm)	135-200
5/32" (4.0 mm)	190-280
3/16" (4.8 mm)	250-340

Guide for Selecting Filler Wire Diameter

Filler Wire Diameter	DC Current Range (Amps)
1/16" (1.6 mm)	20-90
3/32" (2.4 mm)	65-115
1/8" (3.2 mm)	100-165
3/16" (4.8 mm)	200-350

Tungsten Electrode Types

Electrode Type (Ground Finish)	Welding Application	Features	Color Code
Thoriated 2%	DC welding of mild steel, stainless steel and copper	Excellent arc starting, Long life, High current carrying capacity	Red
Zirconated 1%	High quality AC welding of aluminium, magnesium and their alloys.	Self cleaning, Long life, Maintains balled end, High current carrying capacity.	White
Ceriated 2%	AC & DC welding of mild steel, stainless steel, copper, aluminium, magnesium and their alloys	Longer life, More stable arc, Easier starting, Wider current range, Narrower more concentrated arc.	Grey

Aluminum Welding Material

Base Metal Thickness	AC Current for Aluminium	Tungsten Electrode Diameter	Filler Rod Diameter (if required)	Argon Gas Flow Rate	JOINT TYPE
1/16" 1.6 mm	60-80 70-90	1/16" 1.6 mm	1/16" 1.6 mm	15 CFM 7 LPM	Butt/Corner Lap/Fillet
1/8" 3.2 mm	125-145 140-160	3/32" 2.4 mm	1/16"-3/32" 1.6 mm - 2.4 mm	17 CFM 8 LPM	Butt/Corner Lap/Fillet

Welding Rate

Base Metal Thickness	DC Current for Mild Steel	DC Current for Stainless Steel	Tungsten Electrode Diameter	Filler Rod Diameter (if required)	Argon Gas Flow Rate	Joint Type
0.040" 1.0 mm	35-45 40-50	20-30 25-35	0.040" 1.0 mm	1/16" 1.6 mm	10 CFH(5 LPM)	Butt/Corner Lap/Fillet
0.045" 1.2 mm	45-55 50-60	30-45 35-50	0.040" 1.0 mm	1/16" 1.6 mm	13 CFH(6 LPM)	Butt/Corner Lap/Fillet
1/16" 1.6 mm	60-70 70-90	40-60 50-70	1/16" 1.6 mm	1/16" 1.6 mm	15 CFH(7 LPM)	Butt/Corner Lap/Fillet
1/8" 3.2 mm	80-100 90-115	65-85 90-110	1/16" 1.6 mm	3/32" 2.4 mm	15 CFH(7 LPM)	Butt/Corner Lap/Fillet
3/16" 4.8 mm	115-135 140-165	100-125 125-150	3/32" 2.4 mm	1/8" 3.2 mm	21 CFH(10 LPM)	Butt/Corner Lap/Fillet
1/4" 6.4 mm	160-175 170-200	135-160 160-180	1/8" 3.2 mm	5/32" 4.0 mm	21 CFH(10 LPM)	Butt/Corner Lap/Fillet

TIG Welding is generally regarded as a specialized process that requires operator competency. While many of the principles outlined in the previous Arc Welding section are applicable a comprehensive outline of the TIG Welding process is outside the scope of this Operating Manual.

TROUBLESHOOTING

SYMPTOM	POSSIBLE CAUSE	CORRECTIVE ACTION
Unit Does Not Power Up	Unit Is Not Plugged In	Plug In Unit
	Input Power Circuit Breaker Not On	Reset Input Power Circuit Breaker
	The Main Power Switch Is Not Working	Replace Main Power Switch
TEMP Indicator Is On	The internal temperature is too high.	Leave power on and let the fan cool the unit. Output will continue when the unit has cooled.
	Cooling Fan Is Damaged	Replace the cooling fan.
Alarm Indicator Is On	The Input Voltage Is Too High Or Too Low	Meter input voltage to make certain the input voltage falls between 196V and 265V
		If input voltage is correct, contact the welder help line at 888-762-4045 for more help.
TIG Arc Does Not Start	Remote Foot Pedal or Push Button control is broken	Replace Remote Control
	Work Piece is Painted Or Rusty	Remove All Paint And Rust
	Ground Clamp Is Connected Where There Is Paint Or Rust	Remove All Paint And Rust So Ground Clamp Is Connected To Bare Metal
	Ground Clamp Is Not Electrically Connected To The Work Piece	Make Certain The Ground Clamp Is Connected To The Work Piece
	Wrong Shielding Gas	Check to make certain you are using 100% Argon shielding gas
	Main PC Board has failed	Replace the Main PC Board
	HF PC Board has failed	Replace the HF PC Board
Stick Amperage Seems Low	Remote Control is installed	Remove Remote Control
	Amperage is set to low	Use the functional control to set amperage.
No Shielding Gas	Shielding gas bottle is empty	Fill the shielding gas bottle
	Shielding gas bottle supply valve is off	Open valve on shielding gas bottle
	Gas flow rate on regulator is off or very low	Adjust gas flow rate to 20 CFH
	Gas valve has failed	Replace gas valve
	Main PC Board has failed	Replace Main PC Board
Cooling Fan is not working	Cooling Fan Has Failed.	Replace Cooling Fan.
	Cooling Fan Connections have come loose	Inspect cooling fan connections and repair.
No display on digital meters	The Functional Control potentiometer has failed	Replace the Functional Control potentiometer.
	The Functional Control connections have come loose.	Inspect the Functional Control connections and repair.
	Main PC Board has failed	Replace Main PC Board
For Assistance, Contact The Welder Help Line At 800-762-4045		

DIAGRAM & PARTS LIST

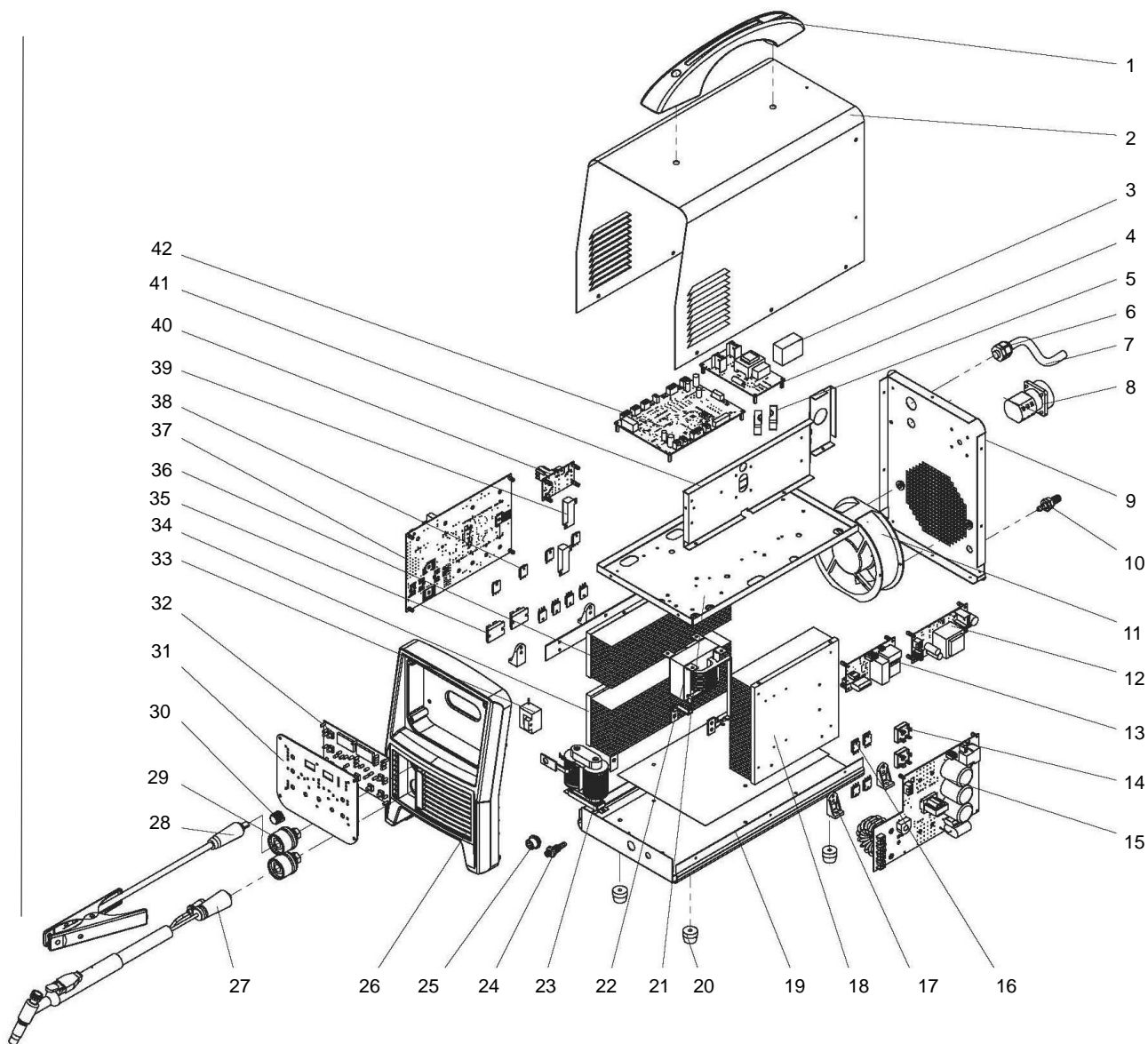

REF #	PART #	DESCRIPTION	QTY
1	105500015	HANDLE	1
2	155500001	ENCLOSURE	1
3	105500016	REMOTE CONTROL MODULE	1
4	105500017	CONTROL PC BOARD	1
5	105500018	INPUT POWER STRAIN RELIEF	2
6	105500019	INPUT POWER CABLE HOLDER	1
7	105500020	INPUT POWER CABLE HOLDER	1
8	105500021	INPUT POWER SWITCH	1
9	155500002	BACK PANEL	1
10	105500023	GAS CONNECTOR RECEPTACLE	1
11	105500024	COOLING FAN	1
12	105500025	POWER SUPPLY PC BOARD	1

REF #	PART #	DESCRIPTION	QTY
13	105500026	PULSE MODULE PC BOARD	1
14	105500027	BRIDGE RECTIFIER	2
15	105500028	INVERTER PC BOARD	1
16	105500029	IGBT	4
17	105500030	PC BOARD SUPPORT	4
18	105500031	HEAT SINK	1
19	105500032	BOTTOM	1
20	105500033	FEET	4
21	105500034	MIDDLE SHELF PANEL	1
22	105500035	REACTOR	1
23	105500036	COUPLING TRANSFORMER	1
24	105500037	FRONT PANEL GAS CONNECTOR	1
25	105500022	5-PIN REMOTE CONTROL RECEPTACLE	1
26	105500039	FRONT PLASTIC PANEL	1
27	105500040	TIG TORCH	1
28	105500041	GROUND CABLE AND CLAMP	1
29	105200136	QUICK CONNECT SOCKET	2
30	105500042	FUNCTIONAL CONTROL KNOB	1
31	155500003	CORNWELL MMW240TIG FACEPLATE	1
32	105500043	FACEPLATE SUPPORT PC BOARD	1
33	105500044	HALL DEVICE	1
34	105500045	RECTIFIER LOWER HEATSINK	1
35	105500046	DIODE	2
36	105500047	RECTIFIER UPPER HEATSINK	1
37	105500048	RECTIFIER PC BOARD	1
38	105500029	IGBT	8
39	105500049	RESISTOR 2	1
	105500050	RESISTOR 1	1
40	105500051	GUN SWITCH ISOLATION PC BOARD	1
41	105500052	CENTER HORIZONTAL PANEL	1
42	105500053	MAIN PCB	1
	105500055	ELECTRODE HOLDER AND CABLE	1
	105200081	INERT GAS HOSE	1
	105200082	INERT GAS REGULATOR/FLOWGAUGE	1
	155500004	OPERATOR'S MANUAL	1

For replacement parts please call (800) 321-8356 .

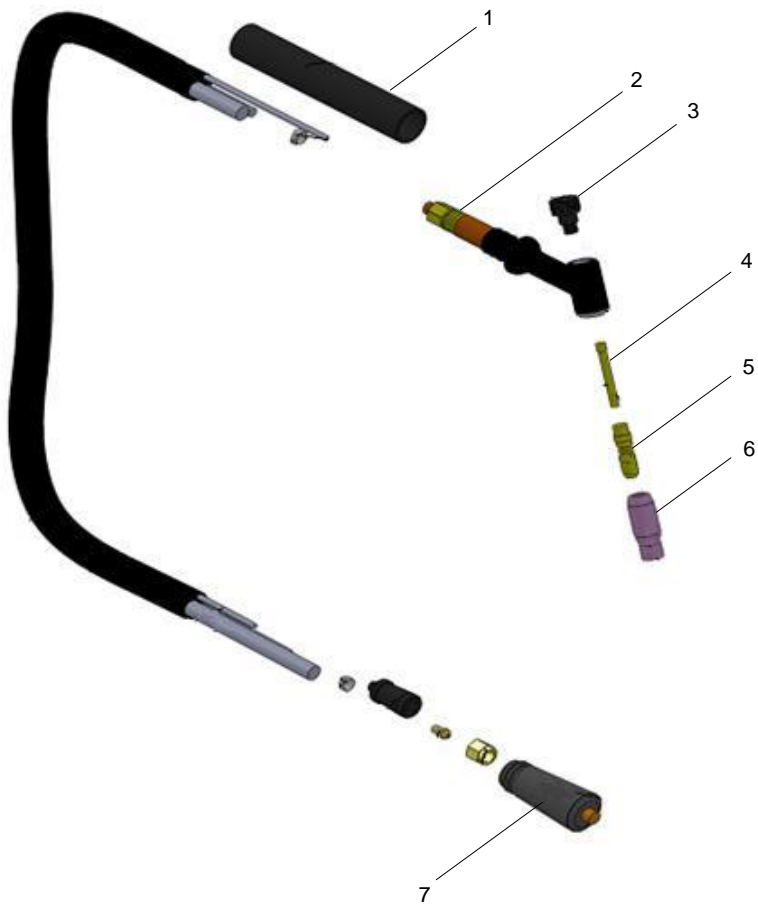

Reference #	Part#	Description	Qty.
1	105500055	TORCH HANDLE	1
2	105500056	TORCH HEAD	1
3	105500006	SHORT BACK CAP	1
	105500005	LONG BACK CAP	1
4	105500011	COLLET 1/16 IN.	1
	105500057	COLLET 5/64 IN.	1
	105500058	COLLET 3/32 IN.	1
5	105500008	COLLET BODY	1
6	105500013	NOZZLE #5	1
	105500014	NOZZLE#6	1
	105500059	NOZZLE#7	1
7	105500060	QUICK CONNECTOR MALE	1



CORNWELL[®]
QUALITY TOOLS

Distributed by
CORNWELL QUALITY TOOLS
667 SEVILLE RD
WADSWORTH OH 44281
www.conwelltools.com
Made in China